

STC Surgical Table Accessory Cabinets

DESIGNED FOR SURGERY.

STORE TABLE ACCESSORIES.

VERY EASY STERILIZATION.

RECESS, SURFACE MOUNT.

MANY SIZES TO SUIT NEED.

ADAPTABLE TO NEW NEEDS.

SIMPLE TO PLAN, INSTALL, USE.



CARR

Carr Is Quality

CARR WAS ESTABLISHED IN 1946 to build the finest quality medical equipment. Based in Santa Monica California, it has prominent installations on all continents, including Antarctica. Its innovative imaging systems were even selected for the SR-71 and Apollo moon landing programs. Our design philosophy: "The greatest sophistication is simplicity" - Da Vinci.



DATA SHEET TABLE OF CONTENTS

Versions.....	3
Features.....	4
Options.....	8
Surface Sizes, Models.....	10
Recess Sizes, Models.....	11
Installation Accessories.....	12
Specifications.....	12
Miscellaneous Notes.....	12
Submittal Drawings.....	13
Install, Ops & Maint. Manual.....	15



STC Versions

SURFACE MOUNTED CABINETS.



RECESS MOUNTED CABINETS.



STC Features

FULL HEIGHT PIANO HINGES for life-time service and effortless operation.

REINFORCED CABINET FACE for added strength and enhanced durability.

WELDED CONSTRUCTION throughout for strength, durability and smooth corners.



SOLID STAINLESS STEEL HANDLES are easy to grip and can be thoroughly cleaned.

NYLON ROLLER DOOR CATCHES provide a smooth and positive closing action.



CARR CORPORATION
carrcorp@aol.com - 800 952 2398
carrcorporation.com - 8/14 - Page 4

STC Features

TRACKS on cabinet back accommodate utility hooks for hanging various table accessories. Hooks can be locked in position anywhere along the track's height. Removable for cleaning.



UTILITY HOOKS are included with each cabinet. Designed for hanging heavier items, each 6" long hook has a silicone rubber top and tip to prevent damage to stored items. Hooks also feature a quick release lock to insure it stays in position. Model UH6. For other optional hooks, see page 8.



CARR CORPORATION
carrcorp@aol.com - 800 952 2398
carrcorporation.com - 8/14 - Page 5

STC Features

SMOOTH INTERIOR EASY TO STERILIZE.
Shelf ladders are flush perforations
in cabinet wall for tough cleaning.

FOR CONTROLLED ENVIRONMENTS.
Stainless is strong, inert, highly chemi-
cal resistant, non-absorbent with a in-
tegral finish that does not chip or flake.

PLANET FRIENDLY. 100% RECYCLABLE.
Stainless is made from 85% recycled ma-
terial. Plastic and wood used in other case-
work use up precious natural resources.

CARR CORPORATION
carrcorp@aol.com - 800 952 2398
carrcorporation.com - 8/14 - Page 6



STC Features

FULLY PROTECTIVE SHIPPING CRATES are carefully designed and built to insure undamaged delivery. Returnable, reusable and made of biodegradable materials.



SIMPLE PLANNING, INSTALLATION. Government preapproved seismic calculations, CAD and submittal drawings ready to use. Step by step illustrated installation manual. Mounting holes provided, no drilling needed. Cabinet connectors insure precise alignment.



CARR CORPORATION
carrcorp@aol.com - 800 952 2398
carrcorporation.com - 8/14 - Page 7

STC Options

SMALL UTILITY HOOKS hold catheters or various other smaller items. Length is 6". Quick release lock. Option CH6.

ENDOSCOPE HANGERS securely hold one scope in a non-marring nylon cradle. Quick release lock. Option EH6. Drip tray for scope hangers. Option DT. Air circulation fan for cabinet. Option FN.

SLOPED TOPS (not shown) make dust removal easy. 9" High. Option ST.

LOCKS can be added for security and be all keyed alike or different. Locks can be changed in just a few minutes. For a door lock, order Option DORLOK. For a drawer lock, order Option DWRLOK.

ELECTRONIC LOCKS offer the convenience of keyless security. Battery powered, numerical keypad. Codes easily changed. Option EDORLOK.

CASTERS are rubber 3" diameter with smooth rolling ball bearings. Some cabinet height restrictions apply. Option CS.

CARR CORPORATION
carrcorp@aol.com - 800 952 2398
carrcorporation.com - 8/14 - Page 8



Small utility hook



Endoscope hanger

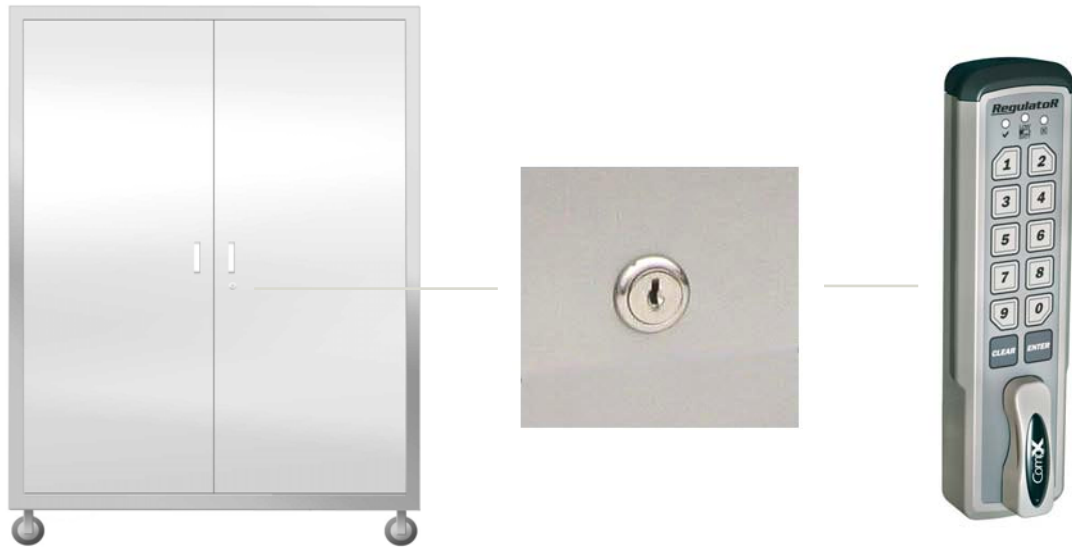

STC Options

PEGBOARDS are stainless steel or white nylon, not wood. Cover the entire back of the cabinet or only a portion. Pegboards accomodate a variety of traditional medium duty hooks and attachments. Option PB.

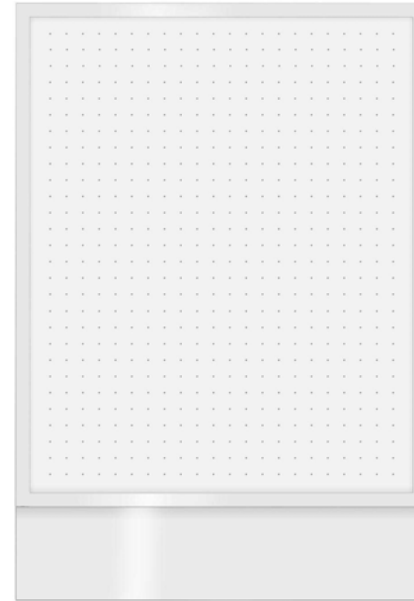

PEGBOARD ATTACHMENT OPTIONS

are secured with screws, chrome plated.

- Hook, 2" long Option PBA1
- Hook, 4 1/2" long Option PBA2
- Hook, 6" long Option PBA3
- Hook, double, 6" long Option PBA4
- Hook, loop, 5" L, 3" W Option PBA5
- Hook, curved, 2 1/2" L Option PBA6
- Hook, curved, 4" L Option PBA7
- Tool holder, 3/4" ID Option PBA8
- Loop, 3" L, 1 3/4" W ID Option PBA9
- Clip, 7/8" L, 1/2" W Option PBA10



PBA1

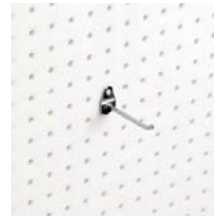

PBA2



PBA3



PBA4

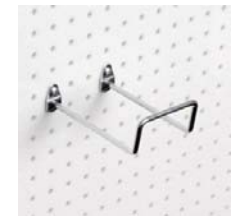

PBA5

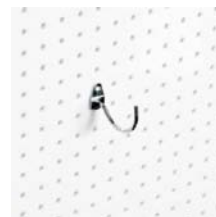

PBA6

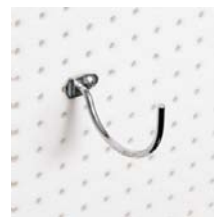

PBA7

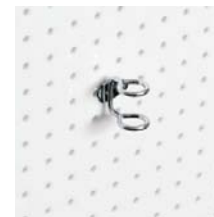

PBA8



PBA9



PBA10

STC Surface Cabinet Sizes, Model Numbers

SLOPED TOP

Model ST width depth
Example: ST4824

FLAT TOP

Model FT width depth
Example: FT4824

CABINET

Model STC width height depth
Example: STC486024

BASE

60" H cabinet 12" H base. All others 3"H.
Model BS width , base height , depth
Example: BS481224

SIDE PANELS

Cosmetic panels for exposed sides.
Model SP height depth
Example: SP6024

CARR CORPORATION
carrcorp@aol.com - 800 952 2398
carrcorporation.com - 8/14 - Page 10

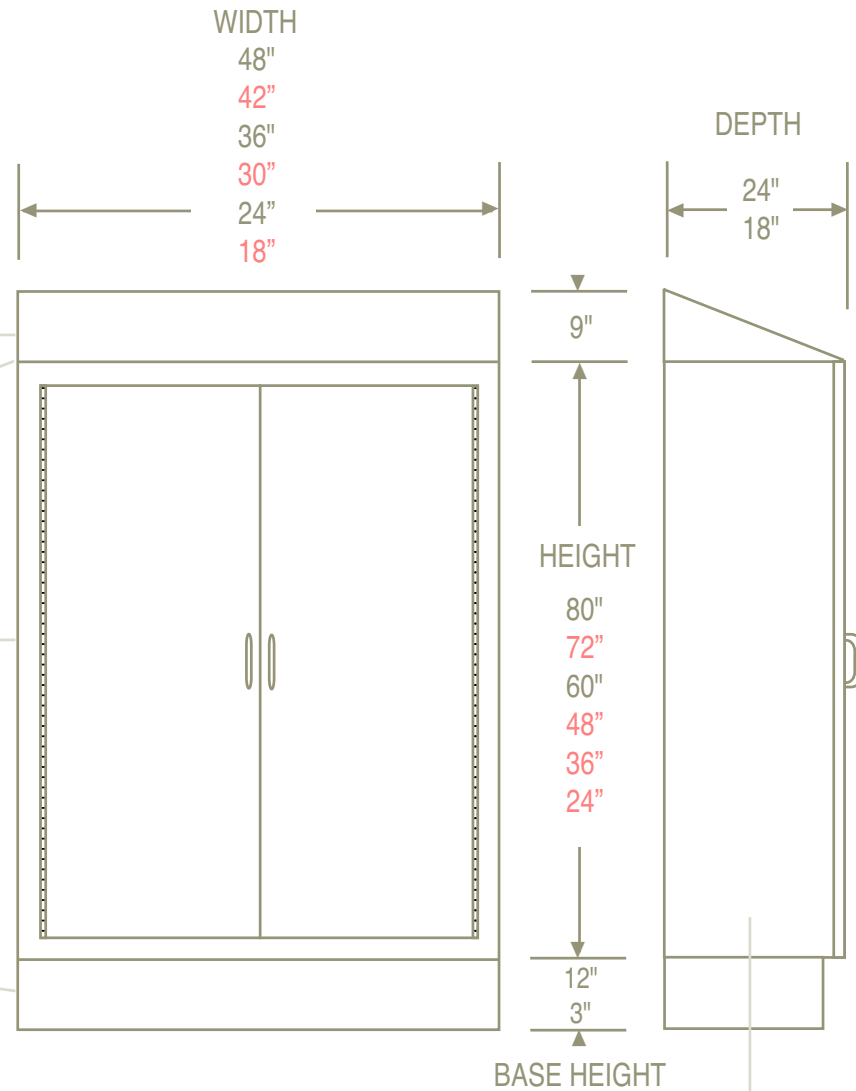

Red indicates non-stock sizes, longer delivery, higher cost.
18" And 24" wide cabinets have one door, hinged right.

STC Recess Cabinet Sizes, Model Numbers

CABINET
Model STC width height depth
Example: STC486024

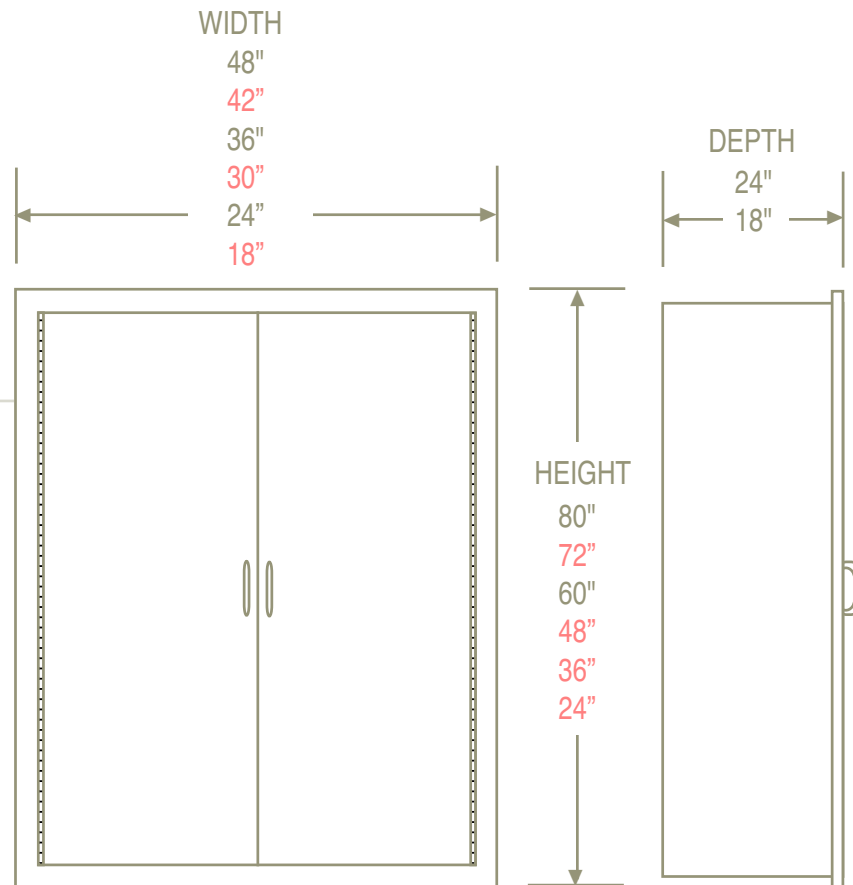

Red indicates non-stock sizes, longer delivery, higher cost.
18" And 24" wide cabinets have one door, hinged right.

STC Information

INSTALLATION ACCESSORIES

CC24 Cabinet connector, 24" H
CC36 Cabinet connector, 36" H
CC48 Cabinet connector, 48" H
CC60 Cabinet connector, 60" H
CC72 Cabinet connector, 72" H
CC80 Cabinet connector, 80" H

FCB24 Filler, cabinet body, 24"H
FCB36 Filler, cabinet body, 36"H
FCB48 Filler, cabinet body, 48"H
FCB60 Filler, cabinet body, 60"H
FCB72 Filler, cabinet body, 72"H
FCB80 Filler, cabinet body, 80"H

FBS3 Filler, base, 3"H
FBS12 Filler, base, 12"H

FFT18 Filler, flat top, 18"D
FFT24 Filler, flat top, 24"D

FST18 Filler, sloped top, 18"D
FST24 Filler, sloped top, 24"D

FSWH Filler, soffit, width, height

SAH Shelf accessory holes

SPECIFICATIONS

DESIGN: Designed to the specifications set forth by Milspec, OSHPOD, JA, EU.

CONSTRUCTION: Heavy gauge type 304 stainless steel, welded modular assembly.

FINISH: No. 4 stainless steel finish. All welds ground, polished. No pits, scratches.

HINGES: Full height stainless piano type. Hinge metal .170" thick. Pin diameter .100". Self lubricating. Tested life of 750,000 cycles.

HANDLES: Solid stainless open design on 4.00" centers, hidden mounting screws.

DOOR CATCHES: Two .250" dia. nylon rollers, plated spring steel receptacles.

DRAWER SLIDES: Ball bearing, full extension & quick release. 250 Lbs. capacity.

GLASS: Tempered double strength safety glass .250" thick, clear, labeled.

SHELVES: Reinforced for strength on all four sides. Height adjustable in .500" increments on flush, built-in ladders.

INSTALLATION: Anchorage holes provided. Cabinet connectors to assure rapid, accurate alignment of multiple units. Complete installation manual included.

MISCELLANEOUS NOTES

LOCK KEYING: Locks are normally keyed alike. Keyed differently on request.

MATERIALS: Cabinets are stainless steel with components made of glass, coated steel, aluminum, nylon, silicone and similar materials. If your application precludes use of a particular material, please advise and we can suggest substitutions.

SHIPPING: Surface cabinets have top, side panels and base shipped separately and assembled in the field to reduce risk of freight damage. On request, cabinets can be shipped with components assembled.

COUNTRY OF ORIGIN: All items are designed and manufactured in the USA.

SEISMIC CALCULATIONS: Complete seismic calculations including OSHPD preapprovals are available on request.

CAD DRAWINGS: Available on request. Ask for Carr document set number 1255.

ORDINARY USE: Carr STC cabinets have not been designed for outdoor use.

PRODUCTION SCHEDULING: Place your order as early as possible in your construction project to insure production and delivery on site at the time needed.

**TABLE ACCESSORY CABINET
SURFACE MOUNTED
MODEL STC**

DATE: 7/1/13 SCALE: NOT TO SCALE
DRAWN BY: *jjr* DRAWING NO. 233

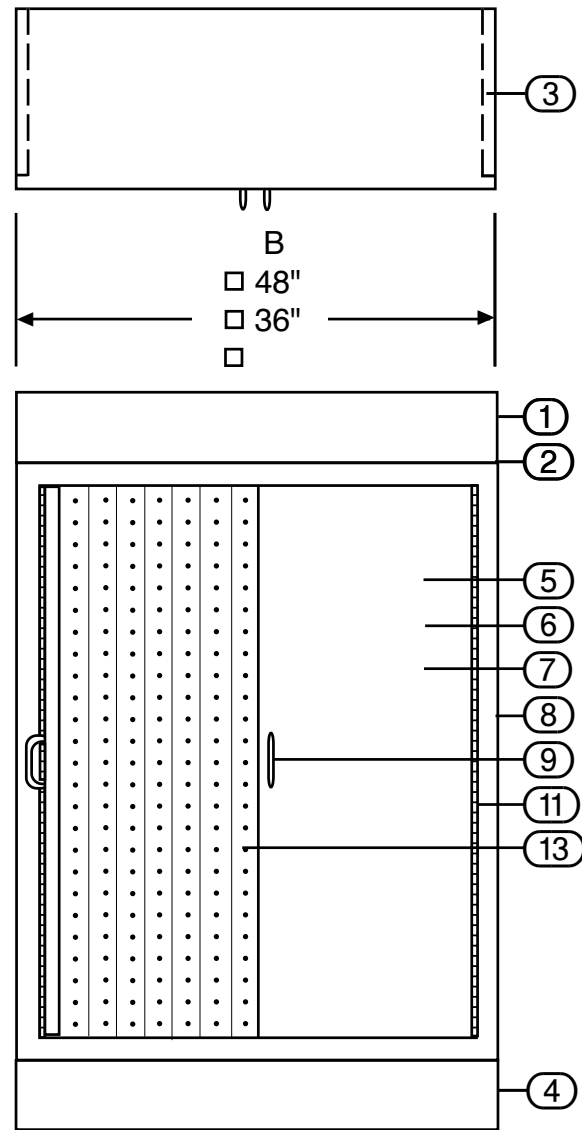
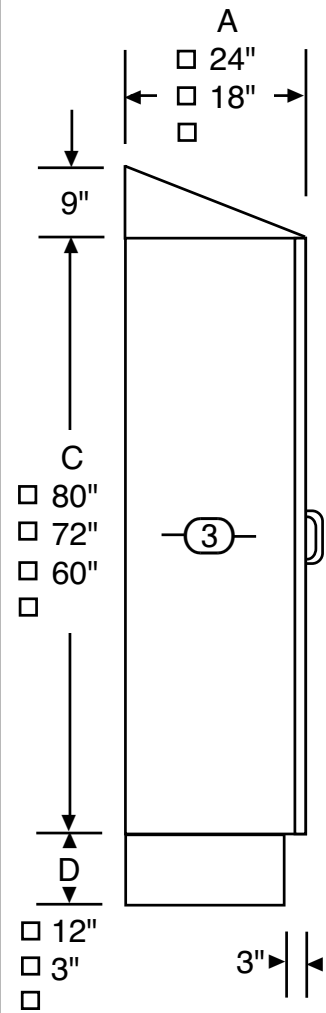

- 1. SLOPED TOP, SS.
- 2. FLAT TOP, SS.
- 3. SIDE PANEL, SS. QTY ____.
- 4. BASE, SS.
- 5. DOOR, SOLID SS, DOUBLE WALL, SOUND INSULATED.
- 6. DOOR, SINGLE GLAZED, DOUBLE WALL, 2" WIDE FRAME, SS.
- 7. GLASS, DBL STRENGTH, TEMPERED, 1/4" THICK, REMOVABLE.
- 8. STAINLESS, TYPE 304, #4 FINISH.
- 9. HANDLE, SOLID STAINLESS.
- 10. FLUSH INTERIOR FACILITATING THOROUGH CLEANING.
- 11. PIANO HINGE, FULL HEIGHT, SS.
- 12. NYLON ROLLER DOOR CATCH, SPRING LOADED, NOT SHOWN.
- 13. HOOK TRACKS, REMOVABLE.
- 14. UTILITY HOOKS, 20 NOT SHOWN.

NOTE: ONLY ITEMS WITH MARKED BOXES ARE INCLUDED.

ALL DIMENSIONS +/- 1/8".



**TABLE ACCESSORY CABINET
RECESS MOUNTED
MODEL STC**

DATE: 7/1/13 SCALE: NOT TO SCALE
DRAWN BY: *jjr* DRAWING NO. 232

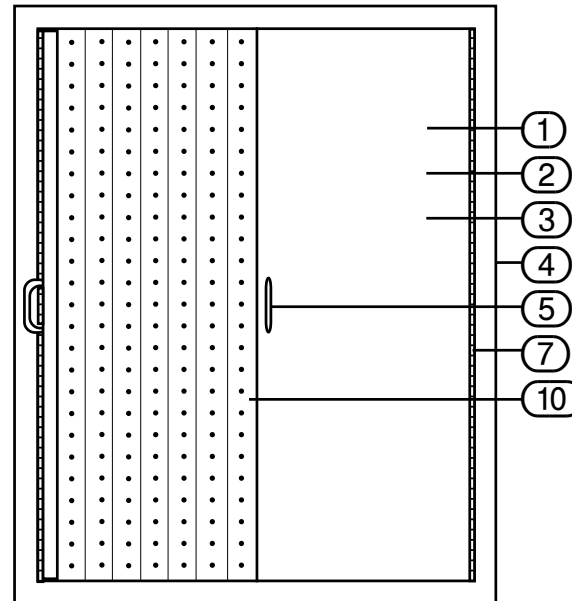
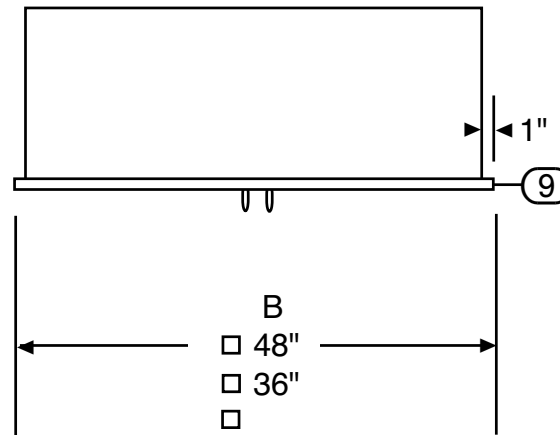
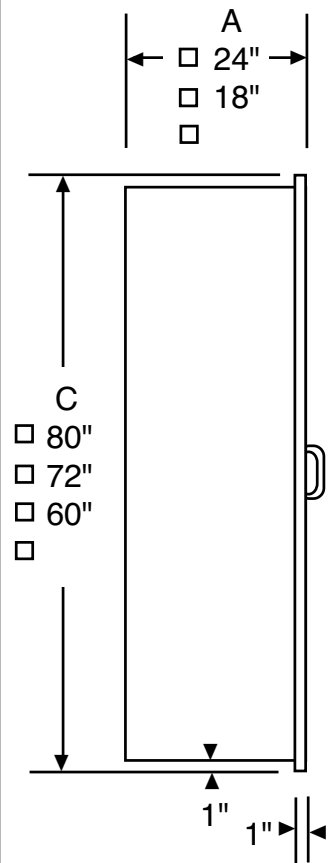

- 1. DOOR, SOLID SS, DOUBLE WALL, SOUND INSULATED.
- 2. DOOR, SINGLE GLAZED, DOUBLE WALL, 2" WIDE FRAME, SS.
- 3. GLASS, DBL STRENGTH, TEMPERED, 1/4" THICK, REMOVABLE.
- 4. STAINLESS, TYPE 304, # 4 FINISH.
- 5. HANDLE, SOLID STAINLESS.
- 6. FLUSH INTERIOR FACILITATING THOROUGH CLEANING.
- 7. PIANO HINGE, FULL HEIGHT, SS.
- 8. NYLON ROLLER DOOR CATCH, SPRING LOADED, NOT SHOWN.
- 9. RECESS FLANGE.
- 10. HOOK TRACKS, REMOVABLE.
- 11. UTILITY HOOKS, 20, NOT SHOWN.

NOTE: ONLY ITEMS WITH MARKED BOXES ARE INCLUDED.

ALL DIMENSIONS +- 1/8".

WALL OPENING:
WIDTH: TOTAL OF "B"-1 1/2".
HEIGHT: "C" - 1 1/2".
DEPTH: "A" - 3/4".

CARR

Carr Surgical Cabinets - Operation And Maintenance

Manual No. 338 Revised 1/13

Placing / removing hooks on STC cabinets:

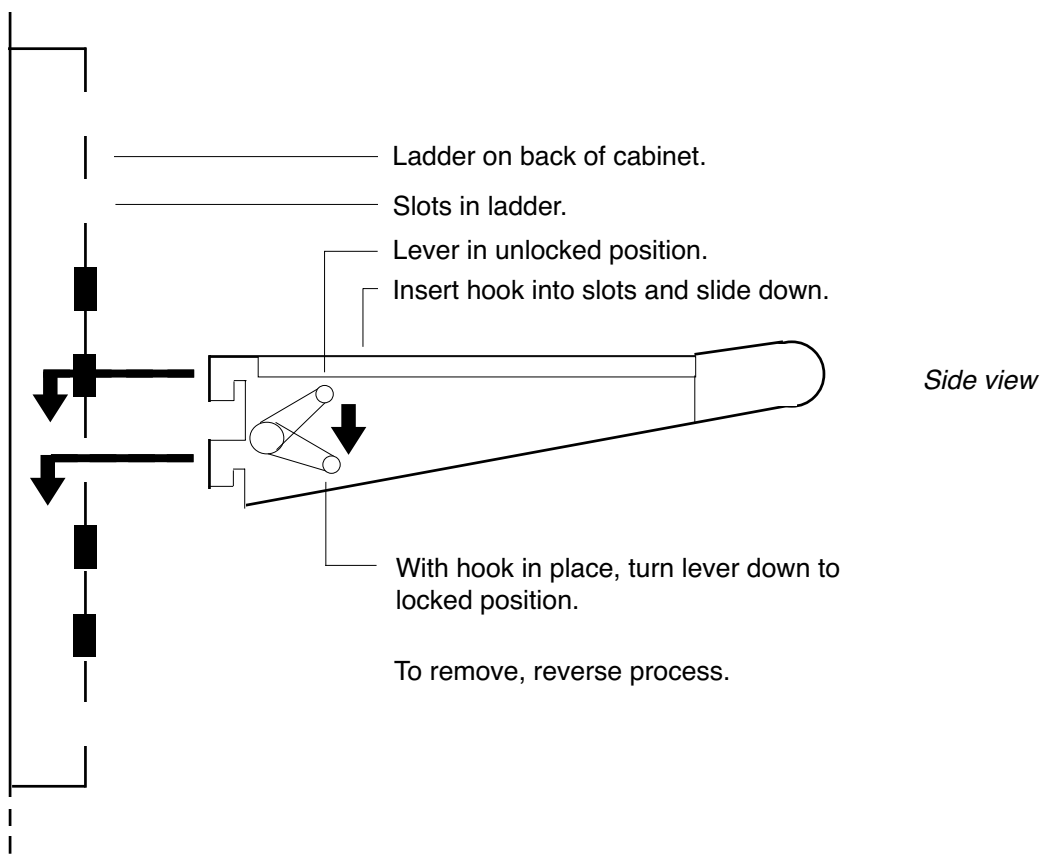

Replacing light bulbs:

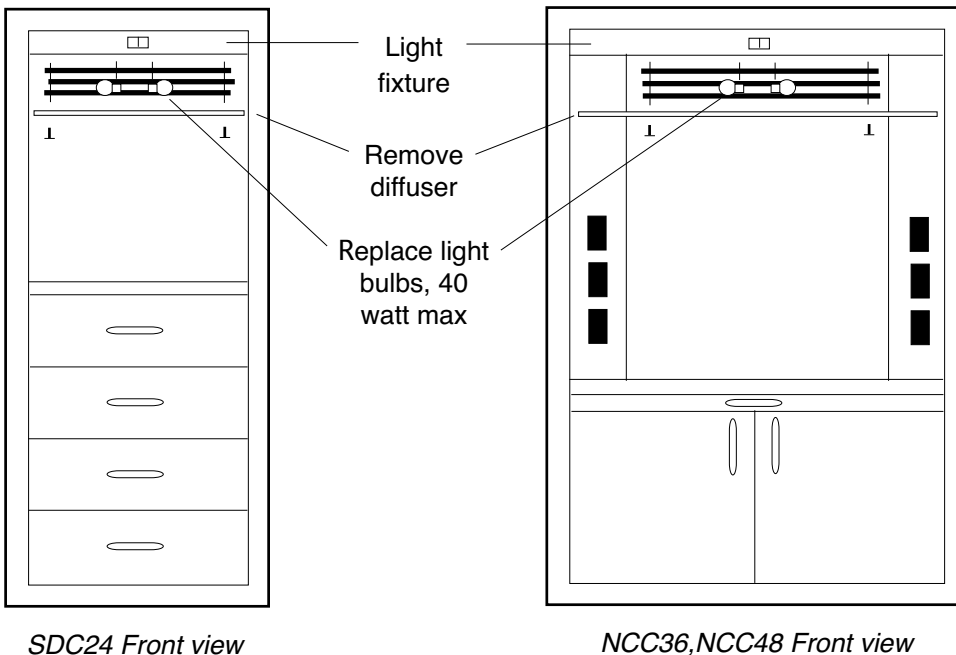

Cleaning:

Clean with a soft cloth dampened with isopropyl alcohol. If using other cleaners, use caution and test first. Some can damage or cause corrosion to the cabinet and its components. Do not expose cabinet to an excess of any liquid. Thoroughly dry cabinet with soft dry cloth. Rub all cloths in direction of grain, not in a circular motion to preserve finish.