

CTS

## Carr Tailored Shelving

TAILORED TO YOUR TYPE: WALL  
MOUNT, FREESTANDING, MOBILE.

TAILORED TO YOUR EXACT SIZE.

TAILOR TO YOUR STORAGE  
NEEDS WITH MANY OPTIONS.

ADJUSTABLE SHELF ANGLE.

GREATER STORAGE EFFICIENCY.

SIMPLE, STRONG, ADAPTABLE.

EASIER INSTALLATION.



**CARR**

# CTS Configurations

WALL MOUNTED. Shelving mounts directly onto wall, secured with bolts.

FREESTANDING. Supports are connected and shelving stands independently on adjustable leveling feet.

MOBILE. Supports are connected and rubber wheels added for mobility.

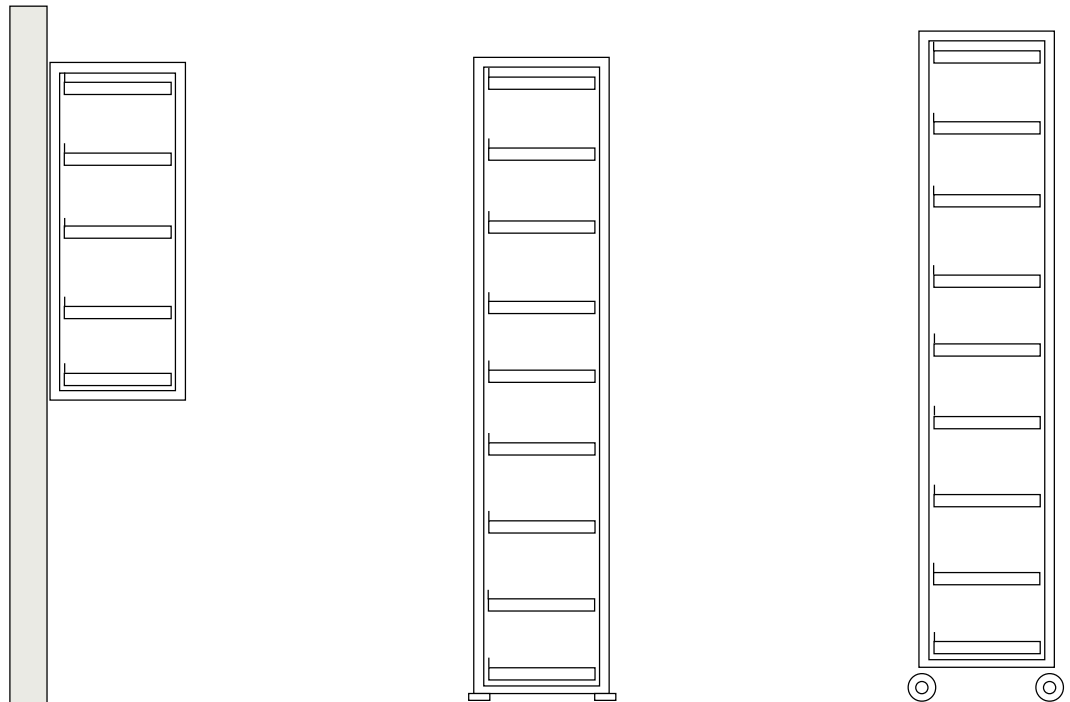

# CTS Shelving Features

SIMPLE IS BETTER. Conventional shelving has a surprising number of parts and subsystems. Why? Complexity is easy to design, simplicity is much harder. Complexity leads to wasted time and unnecessary costs. CTS has only 2 parts: supports and shelves. It is simple and intuitive.

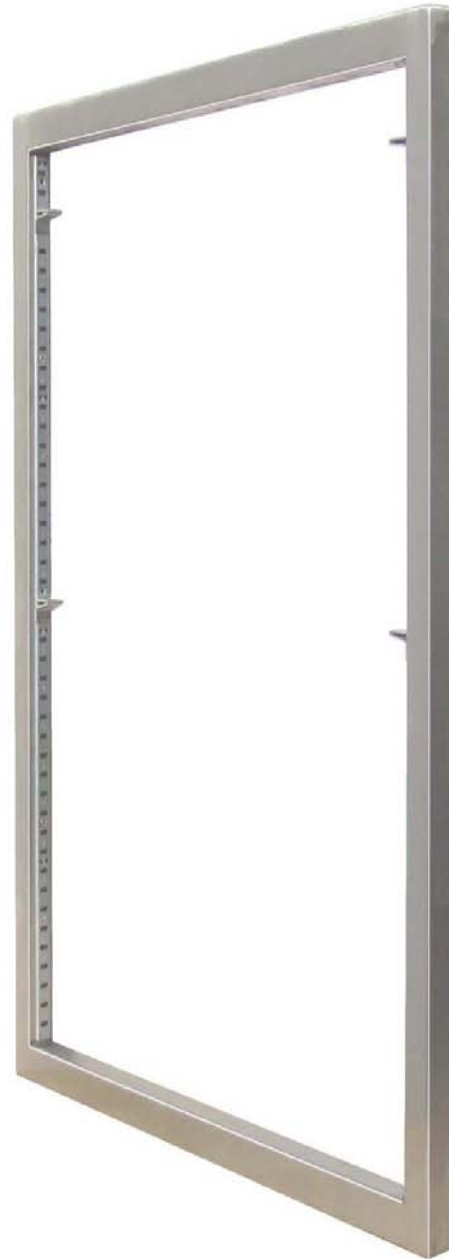

# CTS Shelving Features

**EXCEPTIONAL STRENGTH.** Supports are made of welded 1" square .0625 thick tube. Shelves are heavy gauge and reinforced front, back and sides. Weight capacity is provided.

**SHELF HEIGHT ADJUSTS WITHOUT TOOLS.** Shelves should adjust to changing storage needs, not be de-facto permanent. CTS shelves adjust in .50" increments in minutes.

**HOSPITAL GRADE.** Designed specifically for stringent antibacterial procedures. Shelves are removable without tools in seconds to enable easy access to undersides and back.

**TAILORED FINISH.** CTS is made of either type 304 stainless steel with a # 4 finish, or powder coated pure white electrogalvanized steel.



# CTS Shelving Features

**OBSTRUCTION FREE STORAGE.** Traditional shelf supports intrude into the storage area. These interfere with efficient storage and reduce capacity, especially in longer installations with numerous supports on each shelf. CTS relocates these supports out of the storage area.

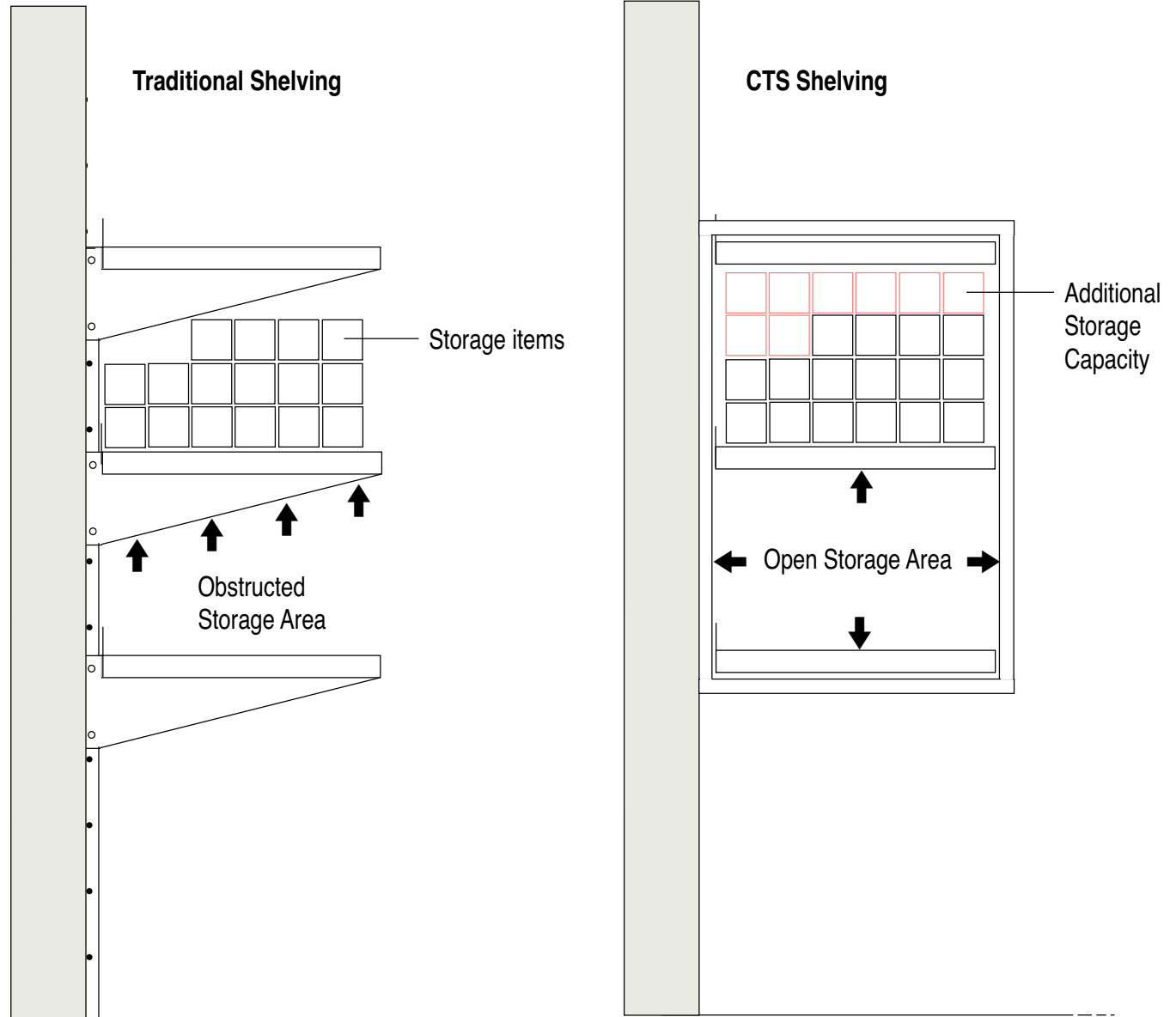

# CTS Shelving Features

EASIER, FASTER INSTALLATION.  
Attach supports to wall and place  
shelves in position. Installation time  
and errors are significantly reduced.



# CTS Shelving Options

**SHELF DIVIDER.** Optional dividers can be locked in place anywhere along the shelf. Simple to unlock and reposition. Typical height is 3" but can be tailored to your needs. Option SD.

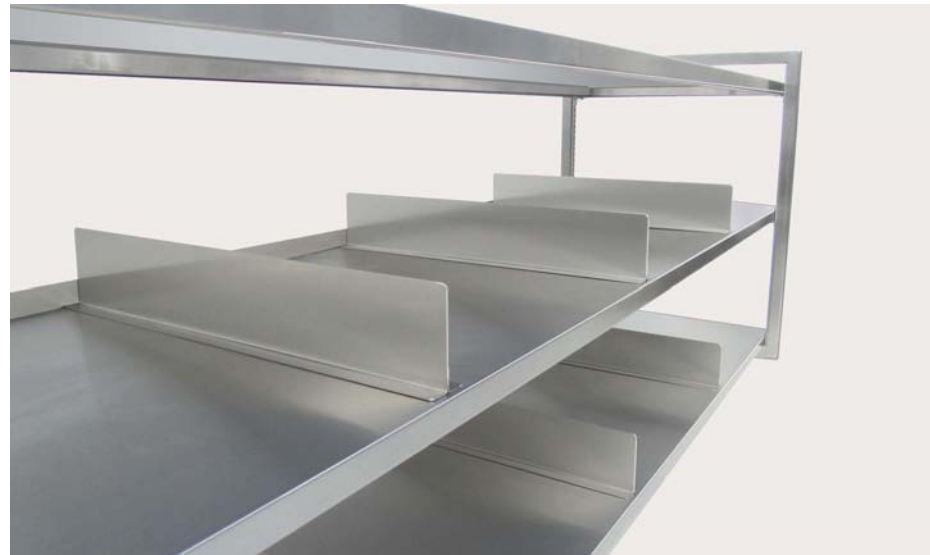

**ADJUSTABLE SHELF ANGLE** for easy access. Using optional clips, shelves can sit flat or angled to a degree tailored to your needs. Turning shelves around puts the backstop in front, preventing contents sliding off. Have some shelves flat, some angled slightly and some angled more on the same shelf set. Option ASA.



# CTS Shelving Options

CLEAR STORAGE BIN OPTION.  
Unique Lexan bins are tailored to  
your exact size for maximum stor-  
age efficiency. Bins slide smoothly  
between shelf dividers. Option CSB.

Clear storage bins work on flat shelves.

Clear storage bins work equally well  
on shelves that have been angled up.

**CARR CORPORATION**  
carrcorp@aol.com - 800 952 2398  
carrcorporation.com - 8/14 - Page 8





# CTS Shelving Options

**OPTIONAL SHELF BACKSTOPS.**  
Backstops keep stored items from sliding off the back of the shelf. They are 1" high and run continuously along entire shelf width. Option SBS.

**ADDITIONAL WEIGHT CAPACITY.**  
Shelf supports can be reinforced with supplemental support arms for even more capacity. Shelves can be fitted with additional shelf reinforcement channels. Option SSA and option SRC.

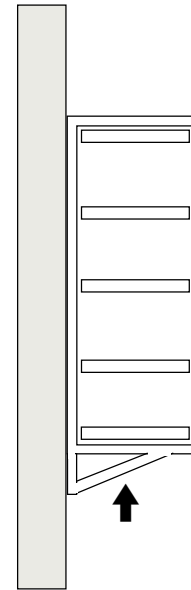
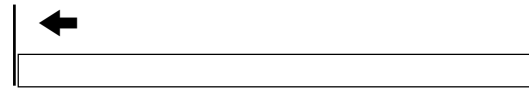

# CTS Shelving Options

CUSTOM DESIGNS. Because of the simplified nature of CTS, it lends itself to custom applications. In this example, a mobile version has double supports for twice the shelf capacity. Tracks were added so shelves could slide in and out. Contact Carr and we are happy to discuss your application.



# CTS Shelving Ordering

TAILOR TO YOUR EXACT SIZE.  
Simply specify width, height, depth,  
shelf quantity and support quantity.

Each shelf set has at least two shelf  
supports. Supports are recom-  
mended every 48" of width.

Maximum width is 96". Additional  
shelf sets can be placed end to end.

For shelf depth, subtract 2.5" from depth.

Call Carr and we can assist you in ob-  
taining a tailored fit for your application.

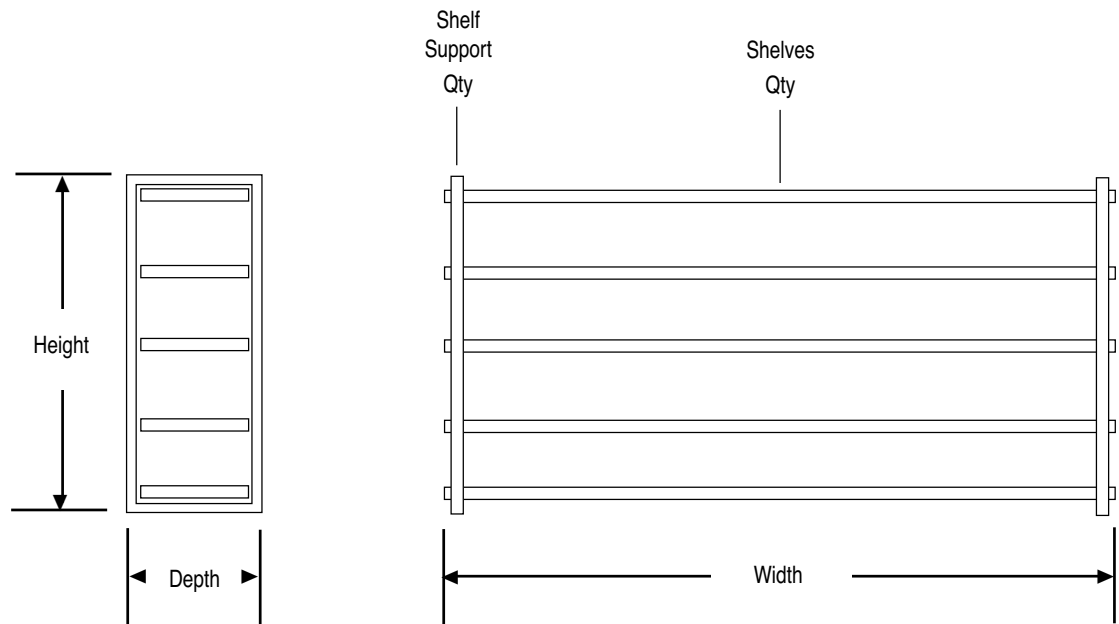

CTS \_\_\_\_\_ - \_\_\_\_\_ - \_\_\_\_\_ - \_\_\_\_\_ - \_\_\_\_\_  
Width    Height    Depth    Shelves    Shelf  
   Qty            Supports  
   Qty

# CTS Shelving Specifications

CTS shelving is constructed of type 304 stainless steel with a number 4 finish. Optionally it may be made of electro-galvanized steel finished with Pure White powder coating throughout.

Rectangular shelf supports are constructed of 1.0" x 1.0" x .0625" thick square tubing heli-arc welded, ground and polished. Provided mounting holes are .250" diameter, hidden by removable 16 gauge shelf standards. Shelf clips have integral shelf locks.

Shelves are constructed of 18 gauge sheet folded, welded, ground and polished. Reinforcement channels are located under front, back and sides. Additional reinforcement channels for increased weight capacity are optional. Shelves are height adjustable in .500" increments. Shelf backstops optional.





**CTS TAILORED SHELVING  
WALL MOUNTED**

**MODEL CTS**

**PROJECT:**

**ROOM:            ELEVATION:**

DATE: 9/1/14    DRAWING NO. 372

BY: *jjr*        SCALE: NOT TO SCALE

- 1. STAINLESS STEEL, TYPE 304 WITH NUMBER 4 FINISH.
- 2. ELECTRO-GALVANIZED STEEL WITH PURE WHITE POWDER COATED FINISH.
- 3. SHELF SUPPORT, 1" X 1" SQUARE TUBING, WELDED.
- 4. SHELF, ADJUSTABLE IN .500" INCREMENTS, QUANTITY \_\_\_\_\_
- 5. SHELF BACKSTOP, OPTIONAL.
- 6. SHELF LADDERS.

- 7. SHELF CLIPS WITH INTEGRAL SHELF LOCKS, NOT SHOWN.
- 8. SHELF CLIP WITH ADJUSTABLE SHELF ANGLE, NOT SHOWN.
- 9. MOUNTING HOLE, .250" DIAMETER, IN BACK.
- 10. SUPPLEMENTAL CAPACITY SUPPORT ARM, OPTIONAL.
- 11. DIVIDER, SHELF, OPTIONAL.
- 12. LEXAN BIN, OPTIONAL, SIZE:
- 13.

- 14.
- 15.
- 16.
- 17.
- 18.
- 19.
- 20.

NOTE: ONLY ITEMS WITH MARKED BOXES ARE INCLUDED.  
NOTE: ALL DIMENSIONS +/- 1/8".

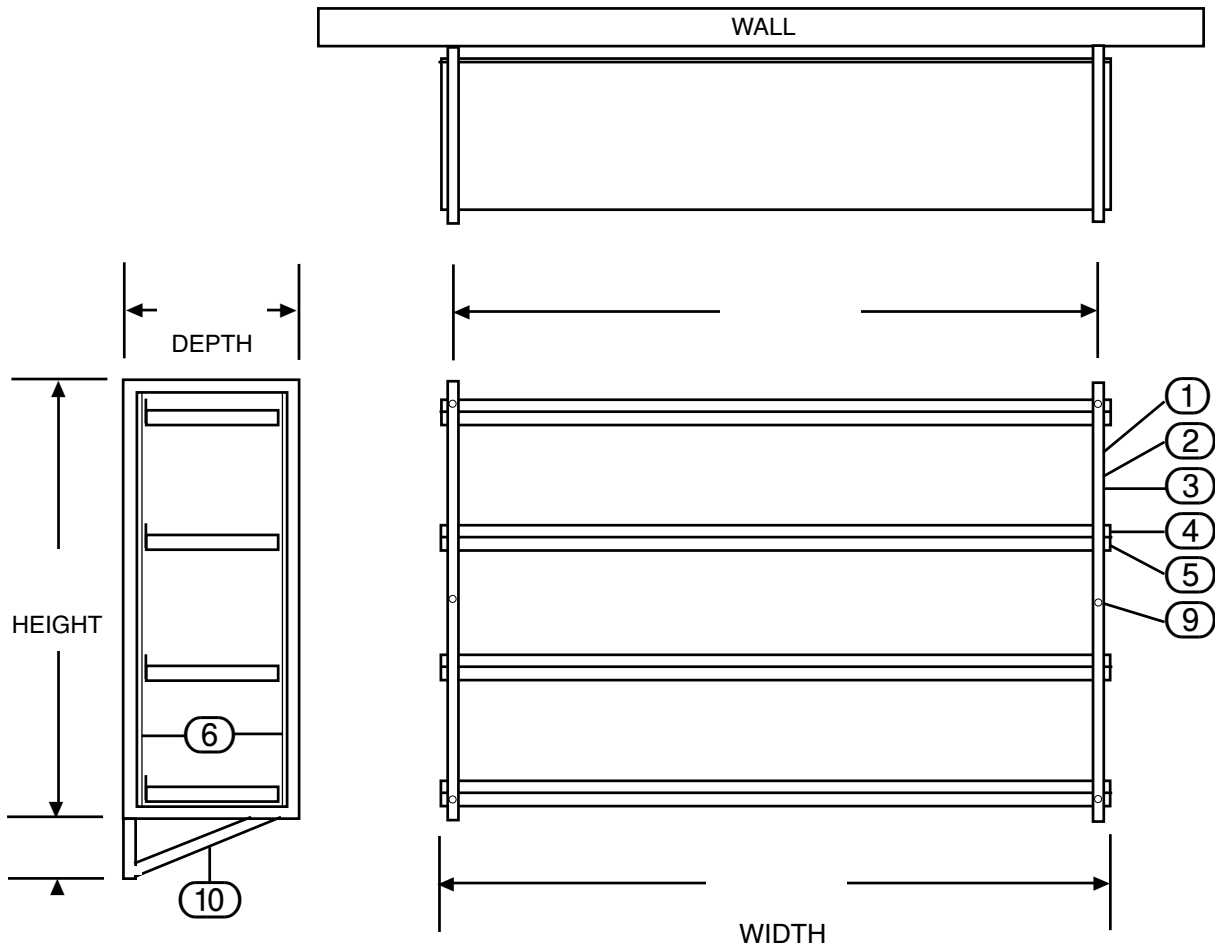

# Carr Corporation

## BACKGROUND INFORMATION

Carr was established in 1946 to build the finest quality medical equipment. Based in Santa Monica California, it has prominent installations on all continents, including Antarctica. Its innovative imaging systems were even selected for the SR-71 and Apollo moon landing programs. Our design philosophy: "The greatest sophistication is simplicity" - Da Vinci.

## CONTACT INFORMATION:

Carr Corporation - 1547 11th Street  
Santa Monica, California, USA. 90401  
Phone 310 587 1113 Fax 310 395 9751  
Toll free phone in USA: 800 952 2398  
Web site address: [carrcorporation.com](http://carrcorporation.com)  
E-Mail address: [carrcorp@aol.com](mailto:carrcorp@aol.com)



**CARR**